



Manufacturer
Brunner-Anliker



Model
Anliker XL Star
Food Processing Machine

High quality made in Switzerland. State-of-the-art materials and technology ensure highest reliability and precision for restaurants, catering, retirement and long term care, and any commercial kitchen that needs to save time and money in their food prep.

Specifications	
Design	<ul style="list-style-type: none"> • Large kidney-shaped filler neck 1/2 gallon (2,100 cm3) • Rotating filler neck on the right for the cutting of Brunoises and Gaufrettes • Tool-free removal of top and plunger • Carry handle on the back • Electric cable 9.85 ft (3 m) long • Plunger made of fiberglass composite with antimicrobial effect • Cutting discs with a diameter of 9-7/16" (240 mm) (ceramics / PTFE coating) • Ceramics / PTFE coating, made entirely of noncorroding material • Extra protection by micro-fuse • Maintenance/service-free gear motor
Function	Cutting, shredding, grating and grinding in up to 50 different ways
Capacity	Up to 900 lbs/h (408 Kg/h)
Voltage	115 V, 60 Hz, (231.02510)
Space requirements	12" x 25.8" x 23.25" (305 x 655 x 590 mm)
Noise	40 dB
Weight	65 lbs (29.5 Kg)
Certificates	CE, CSA, UL
Design and dimensions (in inches)	

Accessories

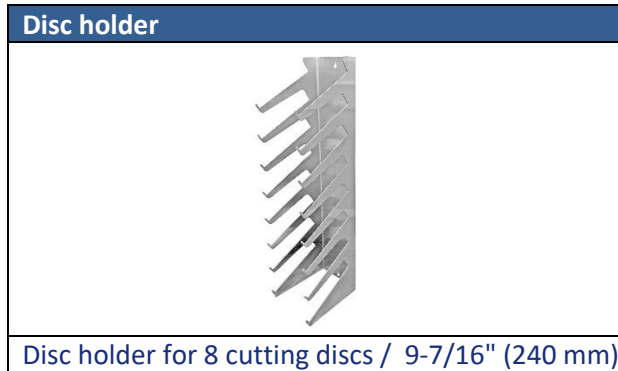



Recommended standard disc set

Starter Kit (5 discs)	
Fine cut 1/32" (1 mm)	F1
Rough cut 1/8" (3 mm)	G3
Juliennes 5/64" (2 mm)	S2
Grating disc for hash browns	Nr. 0
Brunoises 1/8" (3 mm)	BR3

Disc overview

	Slicing	Art. Nr.
Fine cut 1/32" (1 mm)	F1	232.02601
Fine cut 5/64" (2 mm)	F2	232.02602

	Juliennes	Art. Nr.
Juliennes 1/16" (1.5mm)	S 1.5	232.02622
Juliennes 5/64" (2 mm)	S 2	232.02623
Juliennes 1/8" (3 mm)	S 3	232.02624

	Allumettes	Art. Nr.
Allumettes 5/32" (4 mm)	PA 4	232.02631
Allumettes 3/16" (5 mm)	PA 5	232.02633
Allumettes 15/64" (6 mm)	WS	232.02240

	Slicing	Art. Nr.
Rough cut 1/8" (3 mm)	G3	232.02603
Rough cut 5/32" (4 mm)	G4	232.02288
Rough cut 15/64" (6 mm)	G6	232.02606
Rough cut 5/16" (8 mm)	G8	232.02236
Rough cut 3/8" (10 mm)	G10	232.02237
Rough cut 15/32" (12 mm)	G12	232.02238
Rough cut 5/8" (16 mm)	G16	232.02552

	Sickle blade	Art. Nr.
Sickle knife 1/16" (1.5 mm)	SM 1.5	232.02675
Sickle knife 3/32" 2.5 mm	SM 2.5	232.02676
Sickle knife 11/64" 4.5 mm	SM 4.5	232.02678

	Brunoises	Art. Nr.
Brunoises 1/8" (3 mm)	BR 3	232.02639
Brunoises 5/32" (4 mm)	BR 4	232.02640
Brunoises 3/16" (5 mm)	BR 5	232.02641

	Bâtonnets	Art. Nr.
Bâtonnets 16/64" (6mm)	BT 6	232.02241
Bâtonnets 9/32" (7mm)	BT 7	232.02242
Bâtonnets 5/16" (8mm)	BT 8	232.02243
Bâtonnets 3/8" (10 mm)	BT 10	232.02244

	Wavy cut	Art. Nr.
Wavy cut 3/16" (5mm)	SU 5	232.02298
Wavy cut 9/32" (7mm)	SU 7	232.02258

	Dicing	Art. Nr.
Cubes 1/4" (6 mm)	W 6	232.02245
Cubes 5/16" (8 mm)	W 8	232.02247
Cubes 3/8" (10 mm)	W 10	232.02248
Cubes 9/16" (14 mm)	W 14	232.02250

	Cubes WK	Art. Nr.
Body for WK	WK-BODY-7	232.02252
Cubing knife WK	WK-CUBING KNIFE-7	232.02506
Grid 5/16" (8 mm)	WK 8	232.02254
Grid 3/8" (10 mm)	WK 10	232.02255
Grid 9/16" (14 mm)	WK 14	232.02256
Grid 15/16" (24 mm)	WK 24	232.02257

	Shredding	Art. Nr.
Shredding 33/64" (13 mm)	No 000	232.02724
Shredding 7/16" (11 mm)	No. 00	232.02725
Shredding 23/64" (9 mm)	No. 0	232.02700
Shredding 9/32" (7 mm)	No. 1	232.02701
Shredding 15/64" (6 mm)	No. 2	232.02702
Shredding 3/16" (5 mm)	No. 3	232.02703
Shredding 11/64" (4.2 mm)	No. 4	232.02704
Shredding 1/8" (3 mm)	No. 7	232.02707
Shredding 3/32" (2.5 mm)	No. 9	232.02709
Shredding 5/64" (2 mm)	No. 11	232.02711
Shredding 5/64" (1.8 mm)	No. 12	232.02712
Grating - Parmesan	No. 14	232.02714
Fondue 15/32" (12mm)	No. 18	232.02718
Fondue 5/8" (16mm)	No. 19	232.02719
Universal 3/32" (2.5 mm)	No. 23	232.02723

	Tomato cut	Art. Nr.
Tomato cut 3/16" (5 mm)	TO	232.02614

	Shaving cut	Art. Nr.
Shaving cut 1/64" (0.5mm)	HS	232.02621

	Gaufrettes	Art. Nr.
Gaufrettes 5/32" (4 mm)	PG 4	232.02286
Gaufrettes 5/16" (8 mm)	PG 8	232.02293